

 Low Latency Monitor



## PUBLIC AWARENESS MONITOR (PAM)

32" high brightness, low latency monitor with a robust, lightweight design and dust and waterproof IP65 rating

The PAM range is designed for harsh environments, such as public information systems and CCTV, to satisfy the requirements for railways, airports and entertainment areas.

All displays are waterproof, dustproof and meet IP65 specifications. All PAM displays feature high brightness screens ranging from 1000cd/m<sup>2</sup> to 2000cd/m<sup>2</sup> as standard.

Low latency versions have a very short propagation delay and guaranteed no "picture freeze" - ideal for instant feedback requirements.

### KEY FEATURES



Portrait or landscape orientation



Integral Opto isolated video input (DOO only)



Ambient light sensor



Lightweight aluminium and stainless steel



8mm thick laminated glass front



Mains or low voltage operation



Optional sun shield



Automatic brightness and contrast control



Automatic contrast adjustment (PAM\_LL and DOO only)

[www.level9displays.com](http://www.level9displays.com)



# Presenting the Melford Public Awareness Monitor (PAM) range



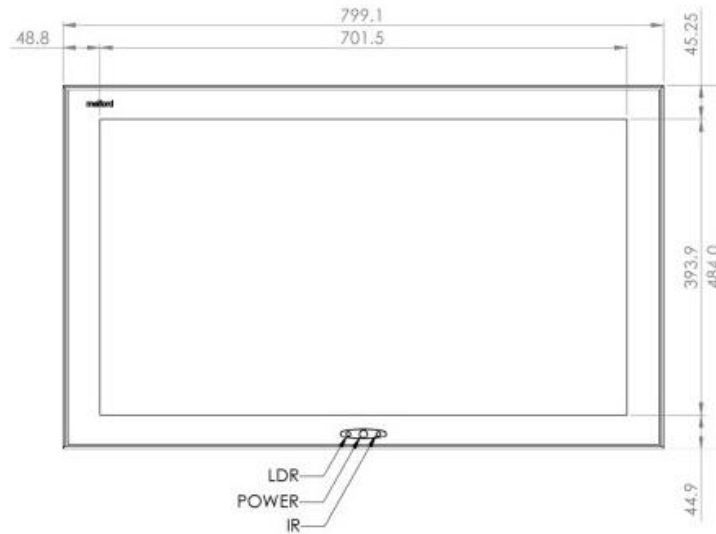
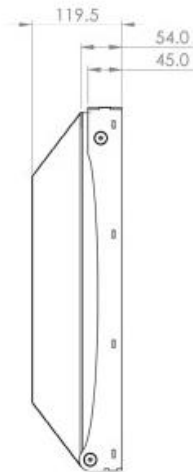
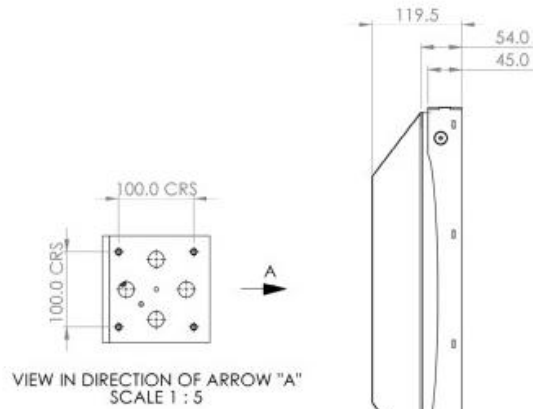
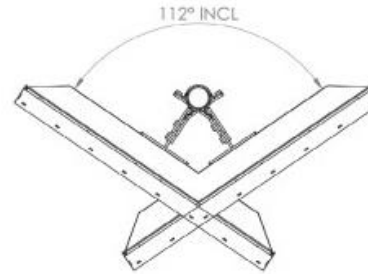
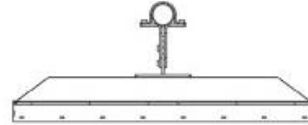
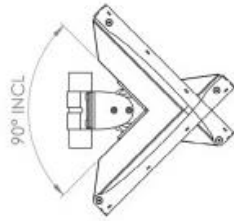
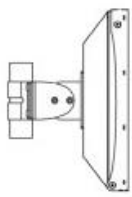

## 32 Inch

Display	Size	32" widescreen
	Dimensions and weight	W x H x D in mm: 794 x 483 x 137.5 Weight: 25kg (approximately)
	Technology	MVA technology
	Resolution	1366 x 768 / 1920 x 1080
	Pixel arrangement	RGB Vertical stripe
	Response time	10ms (typical)
	Contrast ratio	2500:1 Panel only
	Brightness	1000cd/m <sup>2</sup>
	Viewing angle	89,89,89,89 (U,D,L,R)
	MTBF	>100,000 Hrs
	Backlight expectancy	100,000hrs to 50% at 25°C
	Active display area	697.685 mm (H) x 392.256 mm (V)
	Max colour	16.7 Million
	Supported signals	RGB input
RGB H&V syncs		1 - 5V TTL
RGB standard resolutions		VGA 640x480, SVGA 800x600, XGA 1024x768, SXGA 1280x1024, WXGA 1366x768
RGB frequency rate		45 – 90Hz (V) , 15 – 75 Khz (H)
RGB auto detect		VGA Interlaced & Progressive*
Composite video		PAL/NTSC/ 1Vpk-pk [optional feature]
Power supply	Power supply	110V/230V AC 50/60Hz
	Fuse rating	5A (T)
	Power consumption rating	<120W
	Switch on surge	40A for 5mS at 25°C. This figure will increase with temperature.
Input/output signal connectors	RGB signal in	15W HD Sub
	Composite video	75Ω Isolated BNC
	Power AC	IEC connector
User controls	OSD control keys (not fitted as standard)	OS lock feature can be added to prevent accidental activation
	Brightness controls	Automatic/Manual
Environmental	Operating and storage conditions	Operative: -10°C to +40°C Storage: -20°C to +60°C Operational humidity: 30% to 90% (Non condensing)
	Safety operation	It is advisable to operate the monitor at ambient temperature of 25°C if possible. Do not operate the monitor at maximum settings, as it may reduce the life of the product.
Further info	Part number	90RT-PAM/IP65/32HB 90RT-PAM/IP65/32L/1K8 90RT-PAM/IP65/32P/DOO/1K8
	Options	Internal atom based low power PC proximity sensor
	Warranty	1 Year return to factory (limited warranty)

\*Software can be modified for specific input timings

## Why Level 9 Displays?

Level 9 Displays has partnered with Melford Technologies to bring you the latest next generation digital solutions.

Melford Technologies have been offering innovative technology solutions for over 50 years.

Together we provide experienced professional design, project planning, configuration, deployment, and maintenance services for a full one stop shop.

## Contact Us

[johnbaird@level9displays.com](mailto:johnbaird@level9displays.com)

(416) 931-3784

